

WCDMA RAN W18

Learning Services



Why Invest in WCDMA RAN W18 Learning Service ?



- Better controlling and optimizing the network performance
- Optimal Investment
- Efficiently building and maintaining competence over system releases
- Comprehensive competence
- Best fit learning method

Learning Levels & Areas



Fundamentals

WCDMA Fundamentals

Network Development

WCDMA Radio Network Base

WCDMA RAN Design and Tuning

WCDMA RAN Performance Management and Optimization

WCDMA Solutions

Network Operation, Configuration and Troubleshooting

WCDMA RAN Operation

WCDMA RAN Configuration

WCDMA RAN Troubleshooting

Field Personnel

WCDMA Field Maintenance

Node B Commissioning

Delta Training

WCDMA RAN W17/W18 Delta

WCDMA Fundamentals

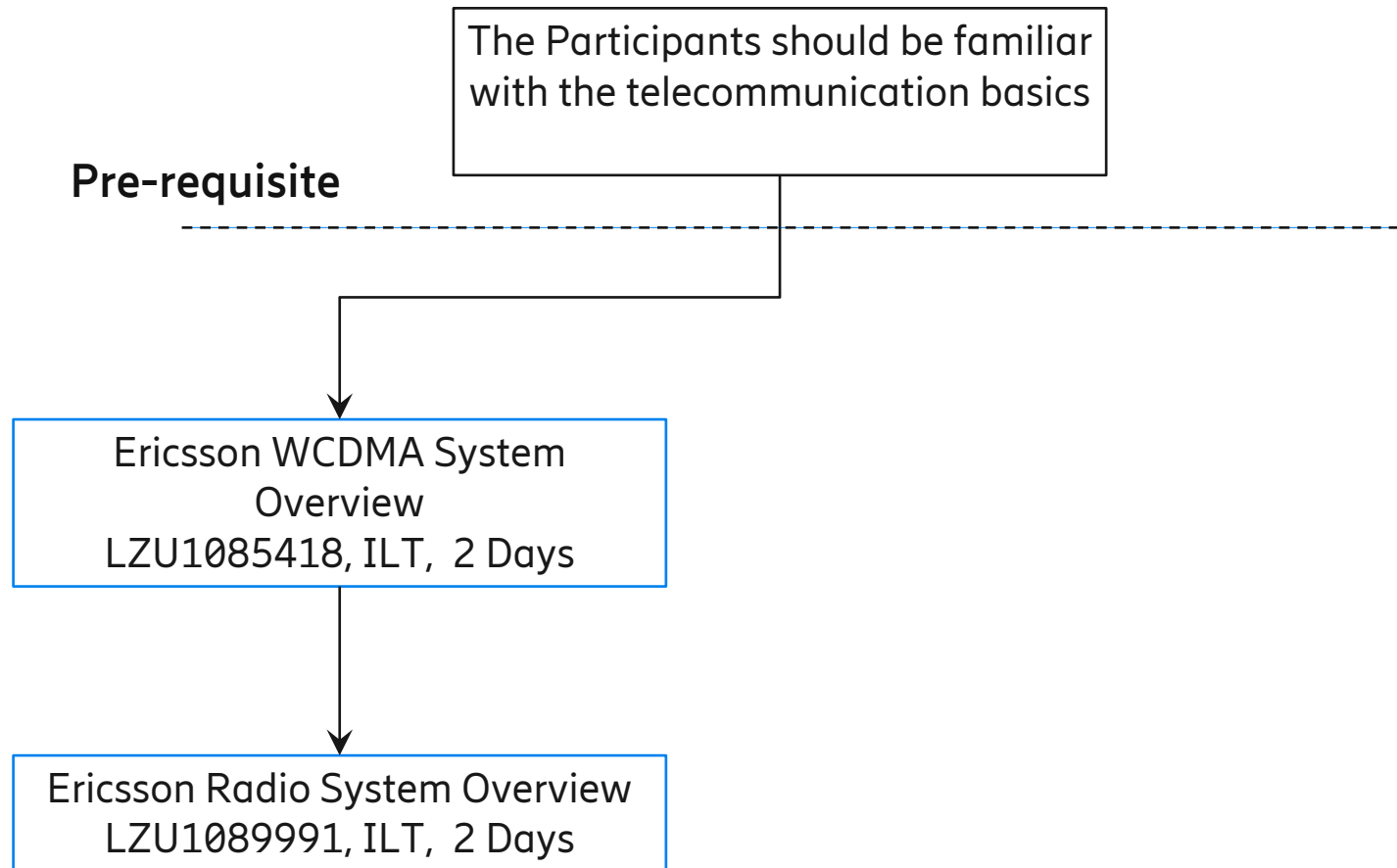

WCDMA Field Maintenance

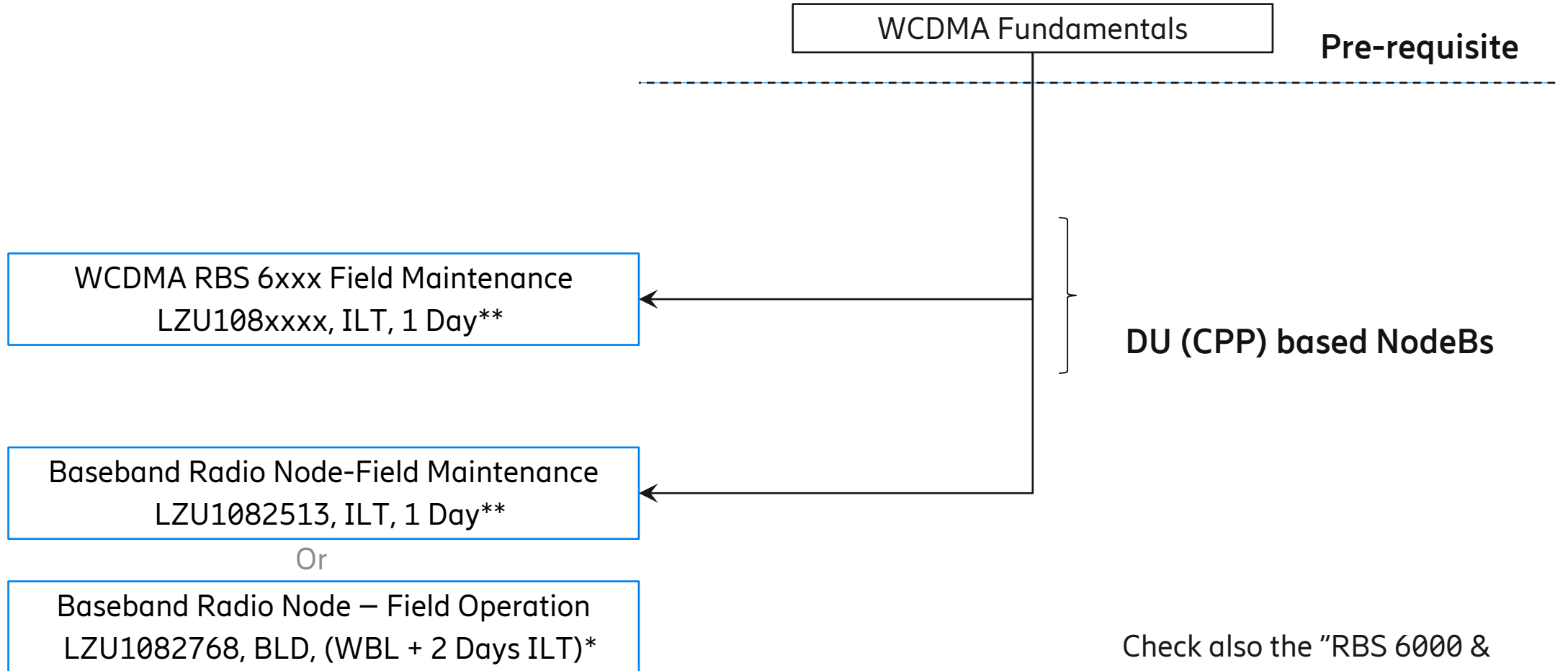

* With practical exercises
** Requires equipment at site

Node B Commissioning

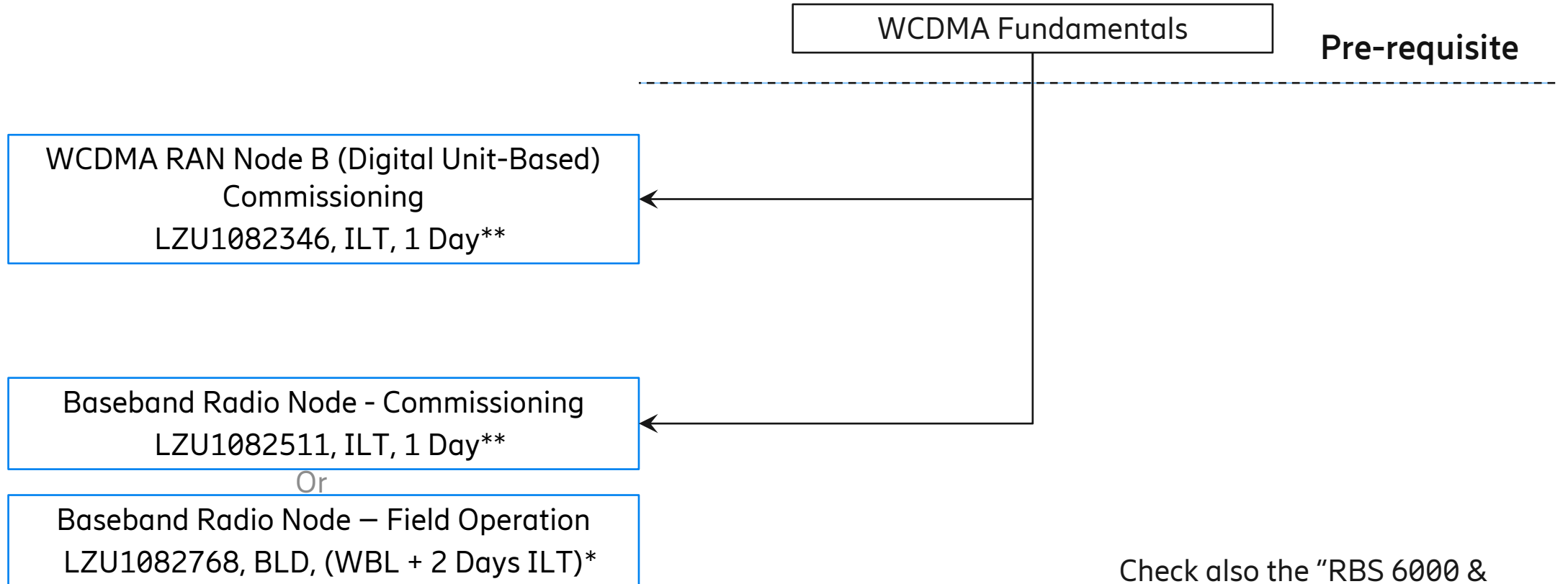

Check also the "RBS 6000 & Baseband" portfolio for Baseband related trainings

- * With practical exercises
- ** Requires equipment at site

WCDMA RAN Network Operation

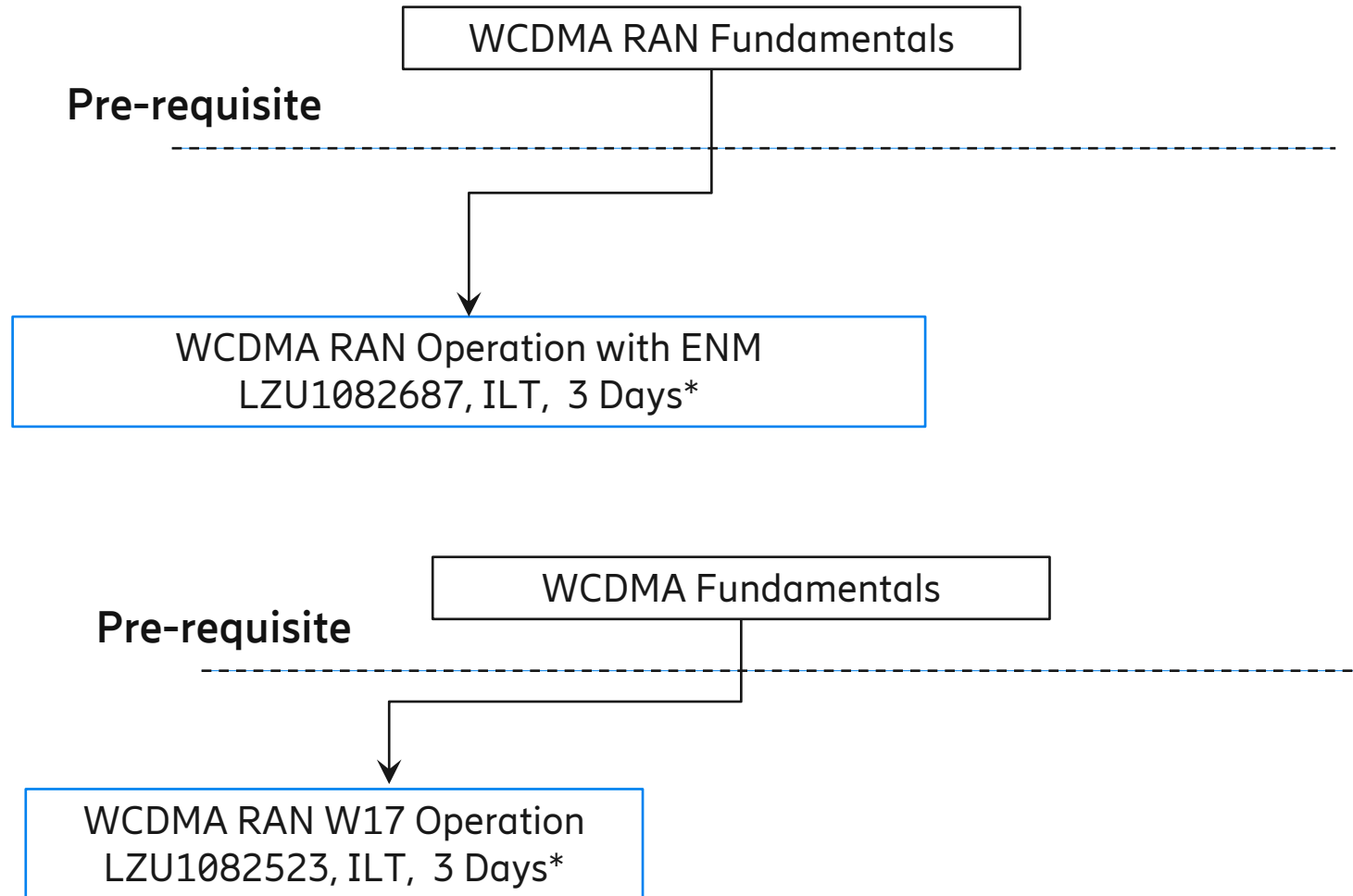

* With practical exercises

WCDMA RAN Configuration

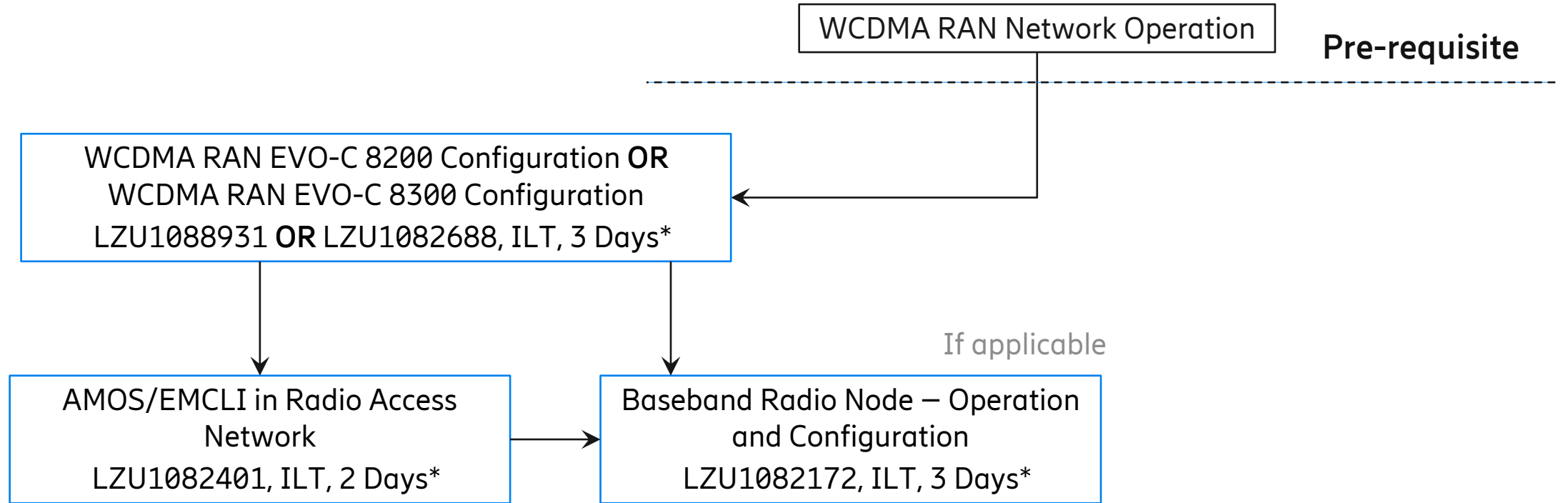

Check also the "RBS 6000 & Baseband" portfolio for other related trainings

* With practical exercises

WCDMA RAN Troubleshooting

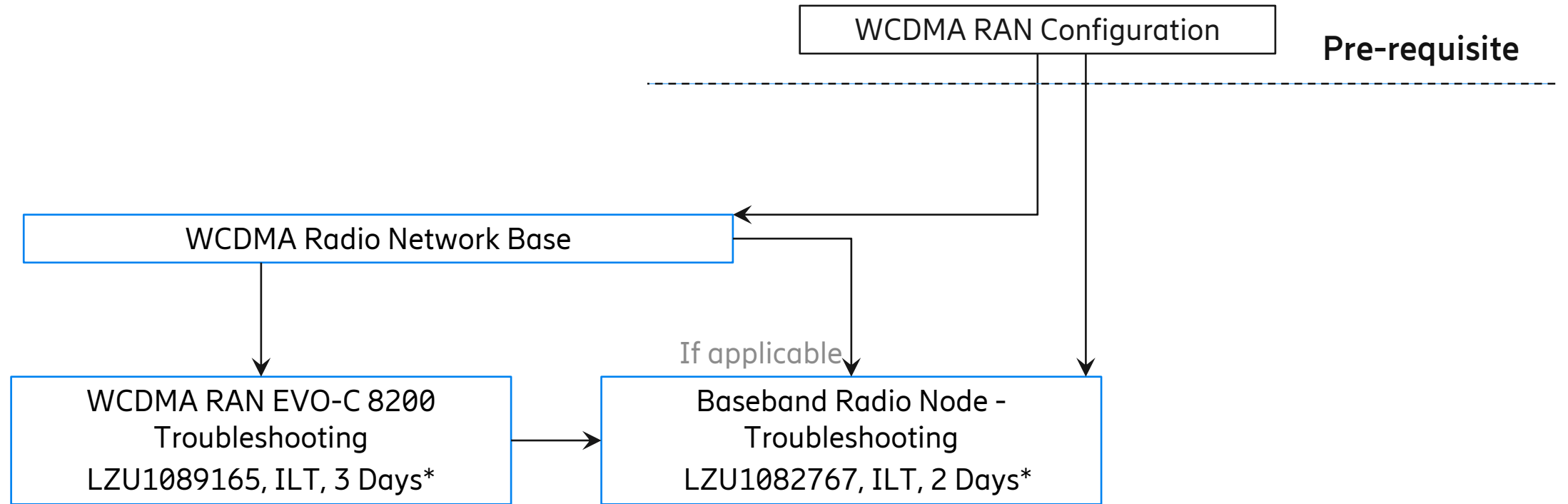

Check also the "RBS 6000 & Baseband" portfolio for other related trainings

* With practical exercises

WCDMA Radio Network Base

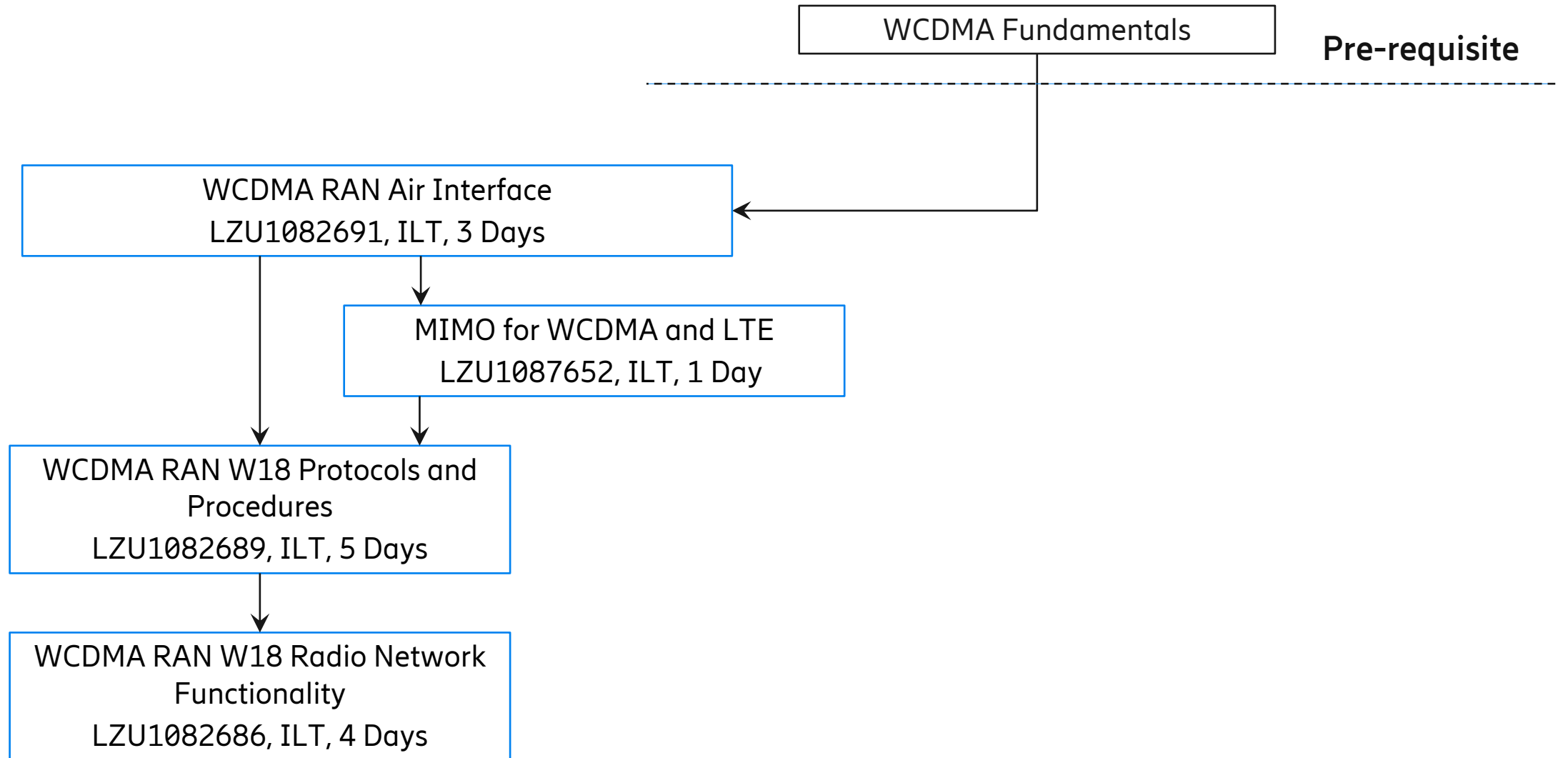

WCDMA RAN Design and Tuning

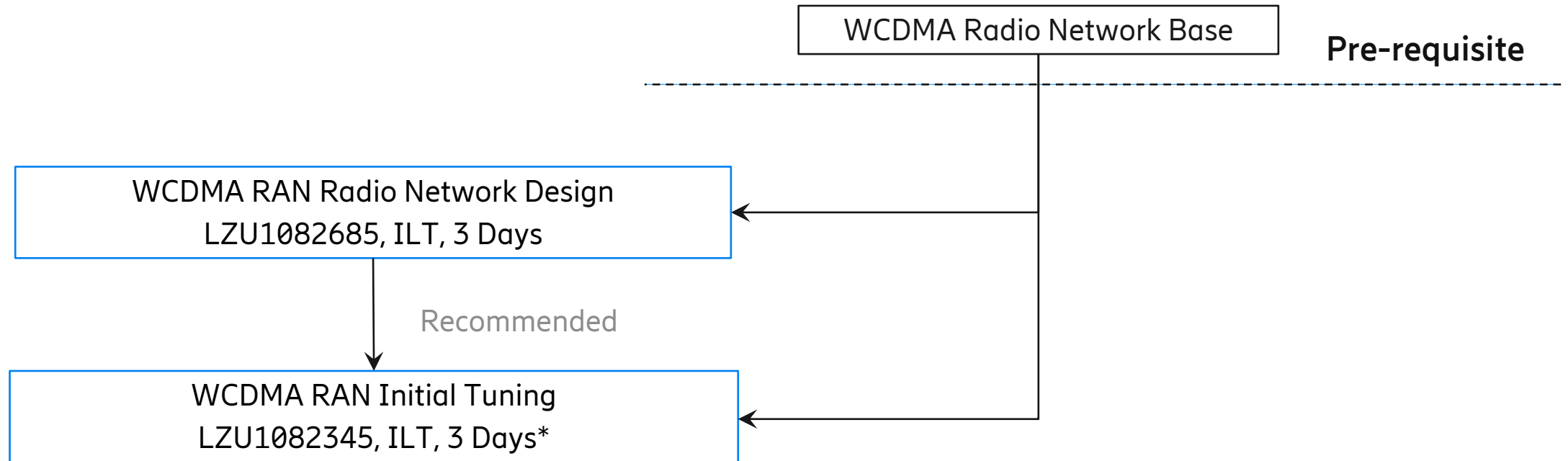

* With practical exercises

WCDMA Performance Management and Optimization

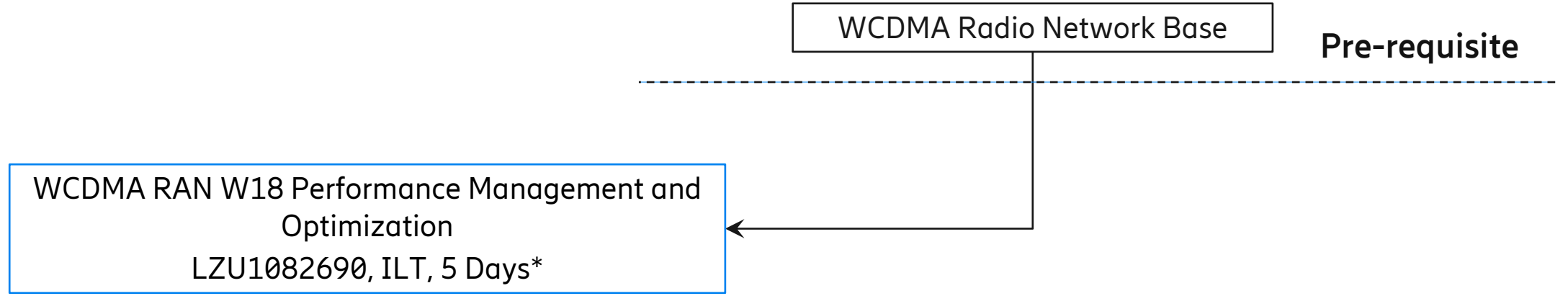

* With practical exercises

WCDMA Solutions

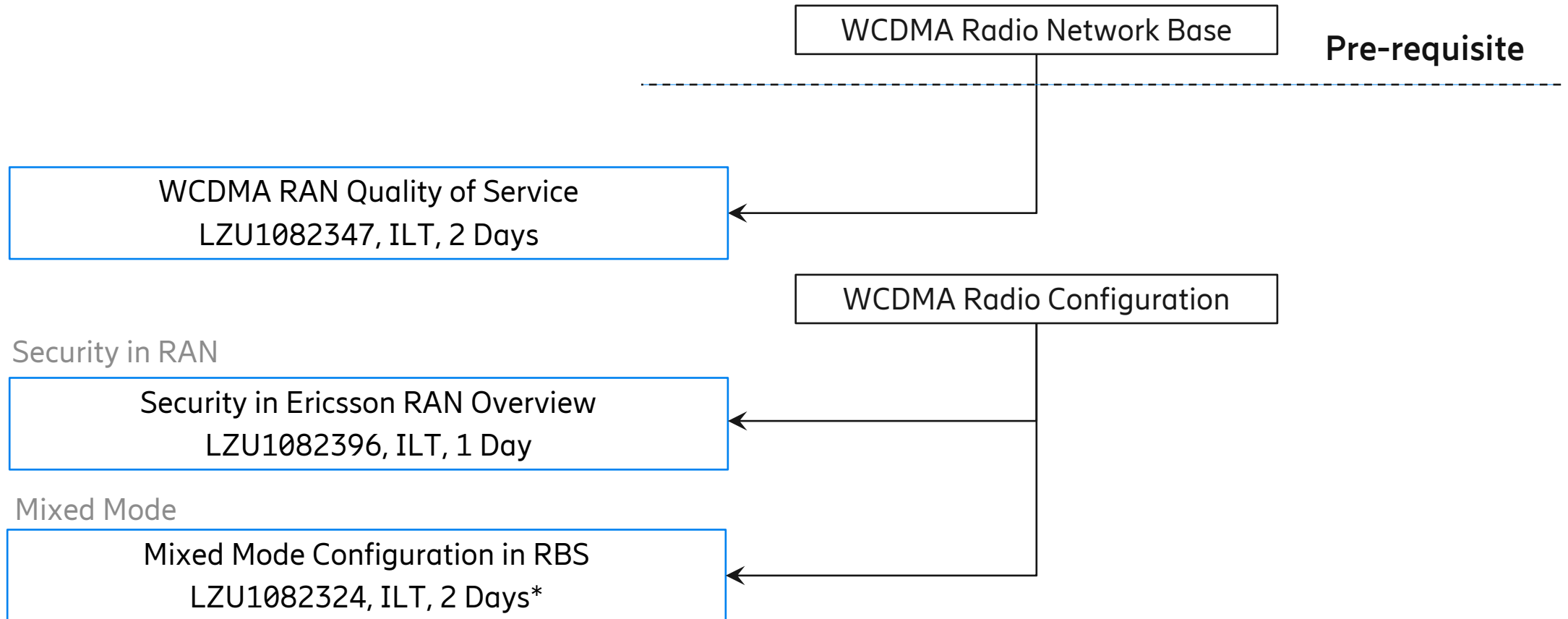

* With practical exercises

WCDMA RAN W16 to W17 Delta

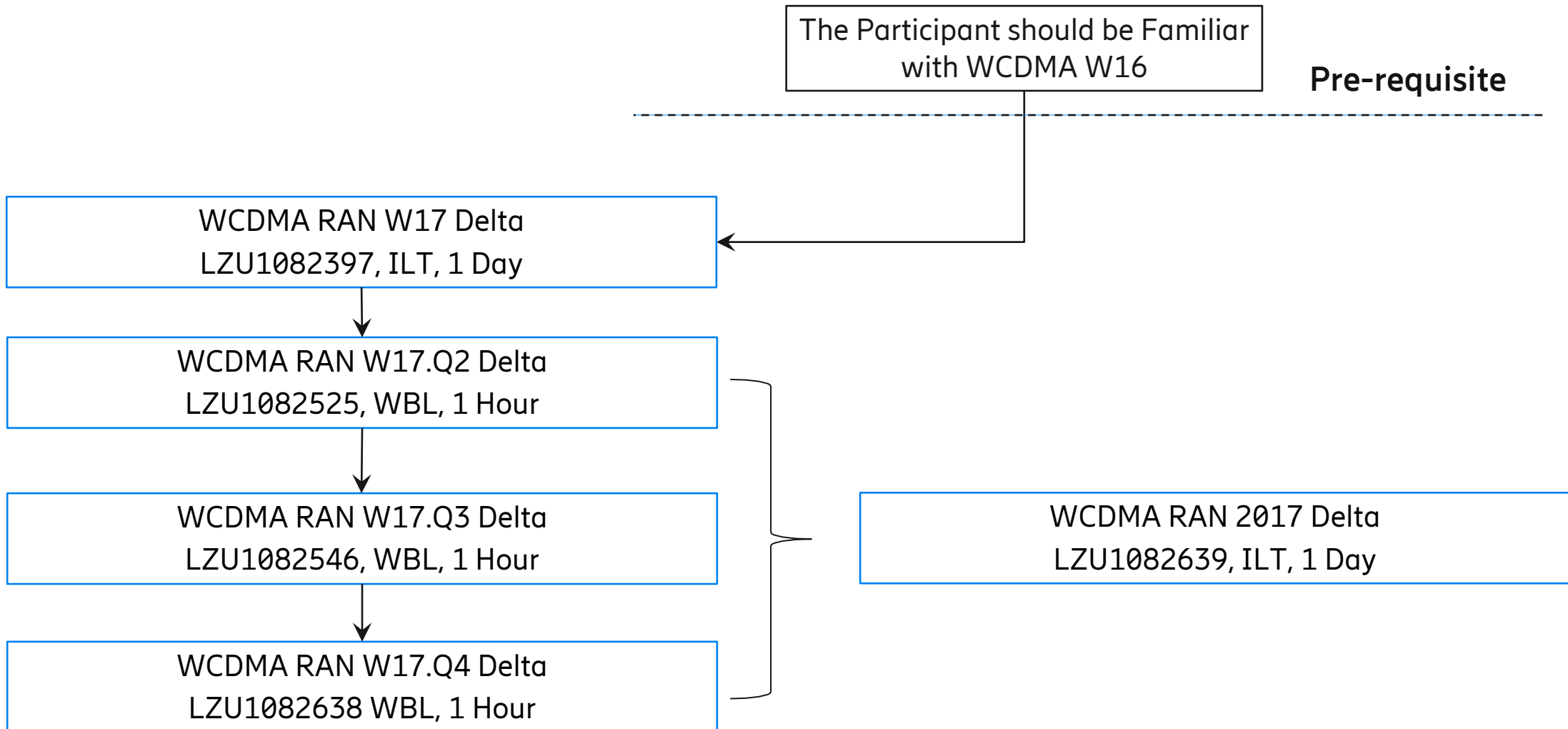

WCDMA RAN W17 to W18 Delta

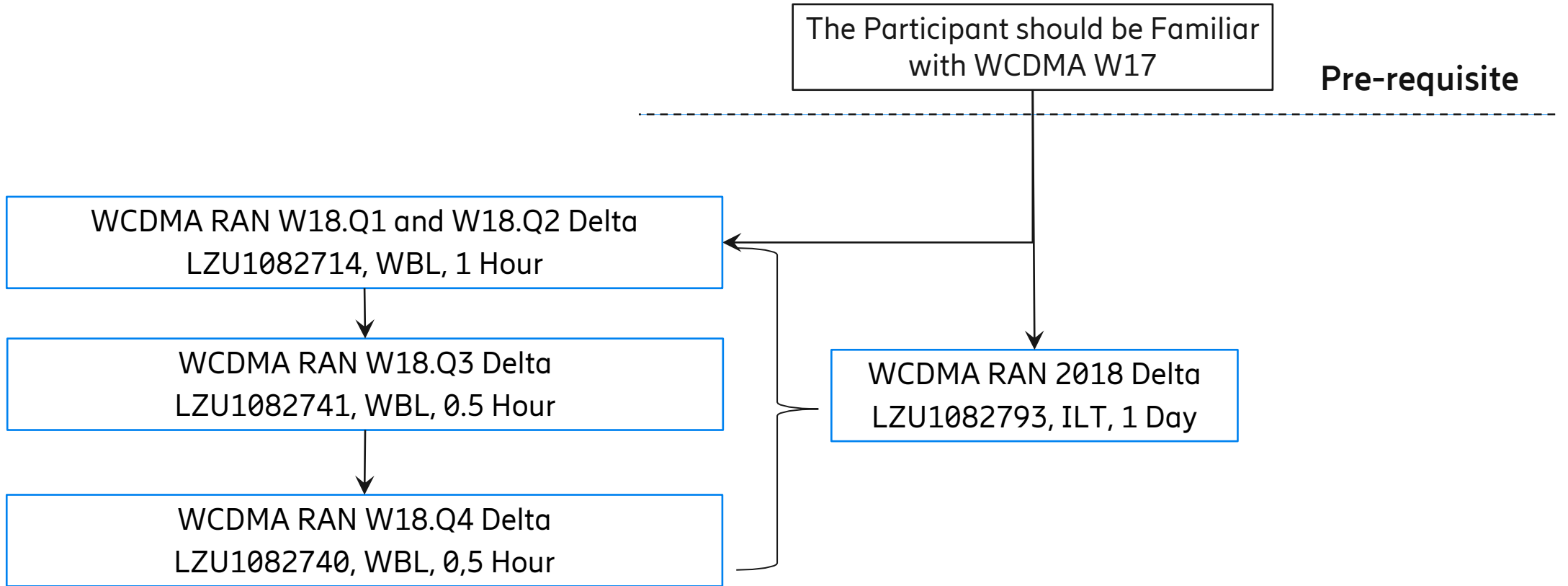

Summary of courses



Course Name – Deltas and Overview	Course Identity	Length	Method
WCDMA RAN 2017 Delta	LZU1082639	1 Day	ILT
WCDMA RAN W18.Q1 and W18.Q2 Delta	LZU1082714	1 hour	WBL
WCDMA RAN W18.Q3 Delta	LZU1082741	0.5 hour	WBL
WCDMA RAN W18.Q4 Delta	LZU1082740	0.5 hour	WBL
WCDMA RAN 2018 Delta	LZU1082793	1 Day	ILT
Ericsson WCDMA System Overview	LZU1085418	2 Days	ILT
Ericsson Radio System Overview	LZU1089991	2 Days	ILT

Summary of courses



Course Name – Radio Network Focused	Course Identity	Length	Method
WCDMA RAN Air Interface	LZU1082691	3 Days	ILT
MIMO in WCDMA and LTE	LZU1087652	1 Day	ILT
WCDMA RAN W18 Protocols and Procedures	LZU1082689	5 Days	ILT
WCDMA RAN W18 Radio Network Functionality	LZU1082686	4 Days	ILT
WCDMA RAN W18 Performance Management and Optimization	LZU1082690	5 Days	ILT*
WCDMA RAN Initial Tuning	LZU1082345	3 Days	ILT*
Course Name –Network Design Focused	Course Identity	Length	Method
WCDMA RAN Radio Network Design	LZU1082685	3 Days	ILT

* With practical exercises

Summary of courses



Course Name – Field Engineer Focused	Course Identity	Length	Method
Baseband Radio Node - Field Maintenance	LZU1082513	1 Day	ILT**
Baseband Radio Node - Commissioning	LZU1082320	1 Day	ILT**
Baseband Radio Node – Field Operation	LZU1082768	WBL + 2 Days	BLD*
WCDMA RAN Node B (Digital Unit –based) Commissioning	LZU1082346	1 Day	ILT**
WCDMA RBS 6xxx Field Maintenance (<i>upon request only</i>)	LZU108xxxx	1 Day	ILT**

* With practical exercises

** Requires equipment at site

Summary of courses



Course Name – Operation, Configuration & Troubleshooting	Course Identity	Length	Method
WCDMA RAN W17 Operation	LZU1082523	3 Days	ILT*
WCDMA RAN Operation with ENM	LZU1082687	3 Days	ILT*
WCDMA RAN EVO-C 8200 Configuration	LZU1088931	3 Days	ILT*
WCDMA RAN EVO-C 8300 Configuration	LZU1082688	3 Days	ILT*
WCDMA RAN EVO-C 8200 Troubleshooting	LZU1089165	3 Days	ILT*
Baseband Radio Node – Operation and Configuration	LZU1082512	3 Days	ILT*
Baseband Radio Node - Troubleshooting	LZU1082767	2 Days	ILT*
AMOS/EMCLI in Radio Access Network	LZU1082401	2 Days	ILT*
Mixed Mode Configuration in RBS	LZU1082324	2 Days	ILT*
Security in Ericsson RAN Overview	LZU1082396	1 Day	ILT
WCDMA RAN Quality of Service	LZU1082347	2 Days	ILT
ENM 18 Operations for Radio Access Network	LZU1082671	5 Days	ILT*

* With practical exercises

Customized Training Solutions

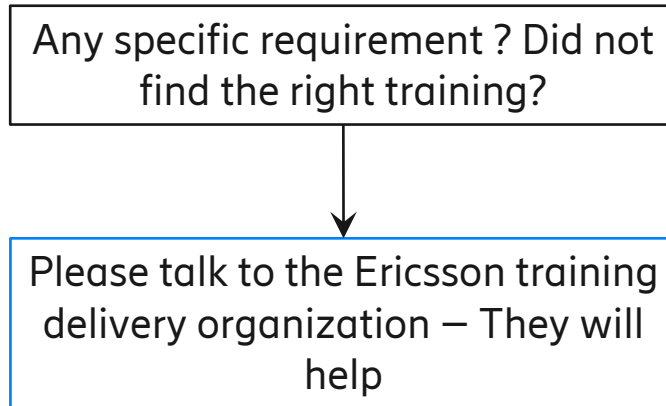

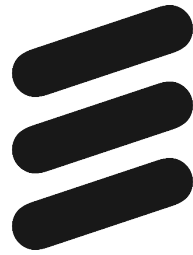

ericsson.com/ourportfolio/services/learning-services